



# CATALOGUE

## GAS SPRINGS

[elsenta.ee](http://elsenta.ee)

elsenta

# CONTENTS



## 6 COMPRESSION GAS SPRINGS

Compression gas springs are a multipurpose product of a simple cylindrical shape with different mounting variants producing an extending power under pressurized nitrogen.

## 13 END FITTINGS M6

End fittings for gas springs form an inseparable part of gas springs

19 WITH M8

24 WITH M10

28 WITH M14

## 29 BRACKETS

We offer brackets from quality materials that facilitate the anchoring of the gas springs.

29 FOR GAS SPRINGS

36 FOR STAINLESS STEEL SPRINGS

# 30

## TRACTION GAS SPRINGS

Traction gas springs have a special structure that makes the piston rod to be pulled in the body of the spring, which is also the starting position of the piston rod in this type of spring.



# 32

## STAINLESS STEEL GAS SPRINGS

Compression gas springs are a multipurpose product of a simple cylindrical shape with different mounting variants producing an extending power under pressurized nitrogen.

# 38

## OTHER ACCESSORIES

In addition to the standard end fittings, we also offer special forks and ball joints made of steel or stainless steel in various dimensions, which are used for the special type of gas spring assembly required by the customer.

# CHARAKTERISTIC

## of gas springs

The gas spring is a multipurpose product of a simple cylindrical shape with different varieties of attachment working as a gas spring with a damping effect on the basis of compressed gas (nitrogen) and oil filling. It helps, or facilitates the opening and closing, extraction or insertion and locking in the limit position on the appropriate, adjusted moving parts of different devices. Gas springs are used in the handling of bodies such as: lifting, lowering, alternating lifting and lowering, creating the forces opposing the movement of bodies in a single movement between two exactly identified end points at a controlled speed. The use of gas springs is numerous and versatile. The options for use are versatile in the engineering industry, food industry, construction industry, the furniture industry, agriculture, maintenance, and also in the private sector for various adjustments and repairs.

Gas springs are an assortment that occurs in virtually every industry sector, and also in homes. The advantage of using a gas spring consists of its long lifetime, trouble-free and maintenance-free operation and high reliability even under extreme climatic temperature changes. Gas springs are manufactured with a piston diameter of 6 mm, 8 mm, 10 mm, 14 mm or 20 mm, depending on the pressure, which the given spring should provide, i.e. the spring of smaller piston diameter can be pressurized at a lower pressure value than a spring with a bigger piston diameter. Spring with different piston diameters are also divided by different lengths and different strokes. For specific customer requirements, it is possible to manufacture a spring of non-standard size or non-standard material after consultation with the manufacturer.

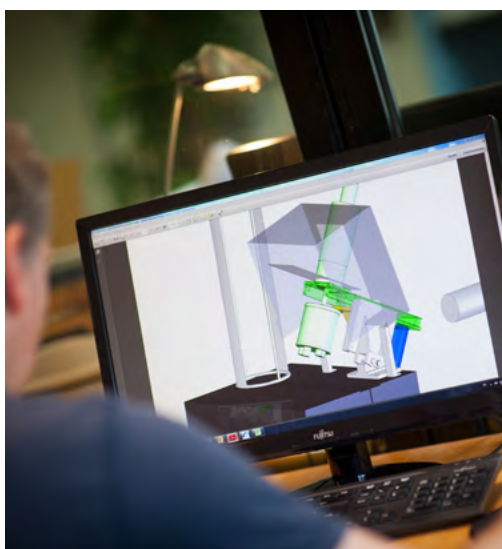

CONTACT

048/414 45 19  
setro@setro.sk

## DIMENSIONAL AND PRESSURE CHARACTERISTICS

All dimensions are in millimetres (mm), the pressure and power values given in Newtons (N). Information about temperatures are given in Celsius (°C)

## CONDITIONS OF USE

Number of strokes per minute: max. 5.  
In case of a greater number of strokes, contact us by phone or email. Period of maintaining original characteristics: average of 30,000 cycles. Loss of technical parameters after this maximum load threshold: max 15%.  
Operating temperature: -30°C to + 80°C.  
the relative temperature: 20°C, deviation of the extraction strength in relation to the temperature: 1% per 3°C.

## WARRANTY

- one-year warranty from the date of filling the gas spring. Example: 01/2007 = first calendar week of 2008,
- in order for the warranty to be recognized, for example after a colour surface treatment, the label with the date of filling must be readable.

## TOLERANCE WHEN PRESSURISING GAS SPRINGS

For each pressurisation of the gas spring, the following tolerance is permissible, depending on the amount of its pressure:

- when pressurising from 50 - 250N = tolerance 20N
- when pressurising from 250 - 750N = tolerance 30N
- when pressurising from 750 + N = tolerance 40N

## ASSEMBLY CONDITIONS

Gas springs are mounted generally downwards with the piston while keeping a minimum gradient of 15°. Horizontal assembly and assembly with the piston upwards must be consulted in advance. Gas springs must not be exposed to lateral pressure. In the case of gas springs with welded eyes it is necessary to leave an allowance of 0.3 to 0.5 mm on the axle in terms of its diameter and an allowance of 0.5 to 1 mm on both sides of the eye. The ordering of gas springs filled with maximum allowable table pressure should be avoided. When varnishing it is necessary to fully protect the gas spring's piston. Never use solvents to clean the piston.

## EXAMPLE OF EXERTION FORCE F1 AT THE VALUE OF 500 N

pri 35°C--+5%=525N  
pri -16°C--12%=440N

## DISPOSAL OF GAS SPRINGS

Gas springs are pressurized by a pressure of 20 to 250 bar. But before their disposal they must remain free of pressure.

For your own safety, we would like to ask that you follow these steps::

- Lightly secure the gas spring in a vise,
- saw off the tube of the gas springs at a distance of 30-35 mm from its edge.

## WARNINGS FOR THE INSTALLATION OF GAS SPRINGS

Protect the piston from the effects of various shocks and splashing during arc welding, from sparks created during grinding, and from the spraying of paint during surface treatment. Never clamp the piston in a vise or pliers without using safety clamps made of lead, aluminium, or copper.

## STORAGE CONDITIONS BEFORE USING THE GAS SPRING

In the case of a storage period up to 3 months the gas springs may be stored in a horizontal position and in a closed room at room temperature. In the case of a longer storage period and in countries with a warm climate, gas springs must be stored in an upright position, with the piston downward.

## WHILE DOING SO, YOU MUST OBSERVE THE FOLLOWING RECOMMENDATIONS

- use safety goggles while working
- use a handsaw
- throw a working cloth over the saw blade
- stop sawing when you hear the sound characteristic for pressure balancing
- release of gas from the gas springs is finished when you are able to move the piston freely with your hand

## TYPES OF GAS SPRINGS IN OUR RANGE

- Compression gas springs
- Traction gas springs
- Gas springs made of stainless steel
- Locking gas springs
- Brackets for mounting gas springs
- Wide range of threaded end fittings

## RELIABLE AND FAST DELIVERY

We deliver products to our customers on time and in the highest quality.



# COMPRESSION GAS SPRINGS

WITH WELDED EYES



# COMPRESSION GAS SPRINGS

## WITH PISTON DIAMETER OF 6 mm

Compression gas springs are a multipurpose product of a simple cylindrical shape with different mounting variants producing an extending power under pressurized nitrogen. The compression of the piston rod into the cylinder compresses nitrogen, resulting in the formation of force, which extends the piston from the cylinder. The amount of force depends on the cross section of the piston rod, the cylinder volume and the amount of nitrogen therein.

The gas springs are finished with welded eyes with a 6.1mm diameter and 3mm eye thickness. The piston rod is made of C35 steel, which is treated by nitriding (QPQ). The cylinder body is made of ST34 2-BK steel and painted with black epoxy paint.

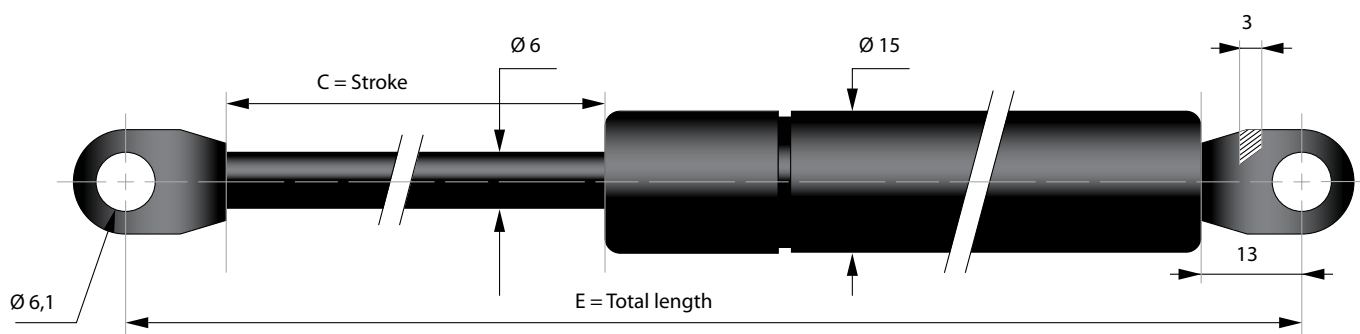

### INSTRUCTIONS FOR ORDERING THE CORRECT TYPE OF GAS SPRINGS:

If you need a gas spring with a piston diameter of 6 mm, with a welded eyes, stroke of  $C=100$ mm and with a force of  $F1=200$ N – the spring will have the following order number ST100 200 D6.

C - stroke (mm)	E - length (mm)	F1 - force (N)	Reference
20	94	30 - 250	ST 020+F1+D6
20	106	30 - 350	ST 020+F1+D6E106
40	145	30 - 400	ST 040+F1+D6
60	185	30 - 400	ST 060+F1+D6
80	225	30 - 400	ST 080+F1+D6
100	265	30 - 400	ST 100+F1+D6
120	305	30 - 400	ST 120+F1+D6
150	365	30 - 400	ST 150+F1+D6

# COMPRESSION GAS SPRINGS

## WITH PISTON DIAMETER OF 8 mm

Compression gas springs are a multipurpose product of a simple cylindrical shape with different mounting variants producing an extending power under pressurized nitrogen. The compression of the piston rod into the cylinder compresses nitrogen, resulting in the formation of force, which extends the piston from the cylinder. The amount of force depends on the cross section of the piston rod, the cylinder volume and the amount of nitrogen therein.

The gas springs are finished with welded eyes with a 8.1mm diameter and 5mm eye thickness. The piston rod is made of C35 steel, which is treated by nitriding (QPQ). The cylinder body is made of ST34 2-BK steel and painted with black epoxy paint.

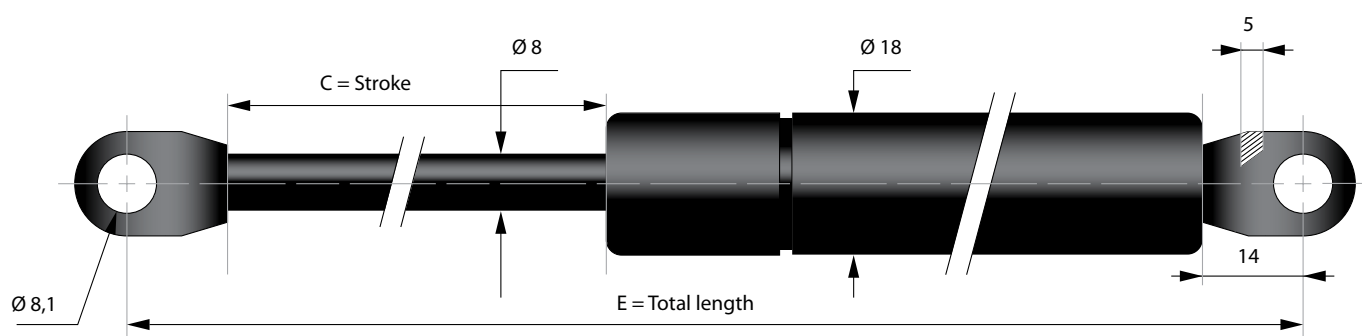

### INSTRUCTIONS FOR ORDERING THE CORRECT TYPE OF GAS SPRINGS:

If you need a gas spring with a piston diameter of 8 mm, with a welded eye, stroke of  $C=100$ mm and with a force of  $F1=500$ N – the spring will have the following order number ST100 500 D8.

C - stroke (mm)	E - length (mm)	F1 - force (N)	Reference
40	155	50 - 750	ST 040+F1+D8E155
60	205	50 - 750	ST 060+F1+D8
72	225	50 - 750	ST 072+F1+D8
80	235	50 - 750	ST080+F1+D8E235
80	245	50 - 750	ST 080+F1+D8
90	255	50 - 750	ST 090+F1+D8
100	285	50 - 750	ST 100+F1+D8
120	325	50 - 750	ST 120+F1+D8
140	365	50 - 750	ST 140+F1+D8
150	385	50 - 750	ST 150+F1+D8
160	405	50 - 750	ST 160+F1+D8
180	445	50 - 700	ST 180+F1+D8
200	485	50 - 700	ST 200+F1+D8
200	500	50 - 700	ST 200+F1+D8E500
220	525	50 - 700	ST 220+F1+D8
250	585	50 - 700	ST 250+F1+D8
250	600	50 - 700	ST 250+F1+D8E600



# COMPRESSION GAS SPRINGS

## WITH PISTON DIAMETER OF 10 mm

Compression gas springs are a multipurpose product of a simple cylindrical shape with different mounting variants producing an extending power under pressurized nitrogen. The compression of the piston rod into the cylinder compresses nitrogen, resulting in the formation of force, which extends the piston from the cylinder. The amount of force depends on the cross section of the piston rod, the cylinder volume and the amount of nitrogen therein.

The gas springs are finished with welded eyes with a 8.1mm diameter and 5mm eye thickness. The piston rod is made of C35 steel, which is treated by nitriding (QPQ). The cylinder body is made of ST34 2-BK steel and painted with black epoxy paint.

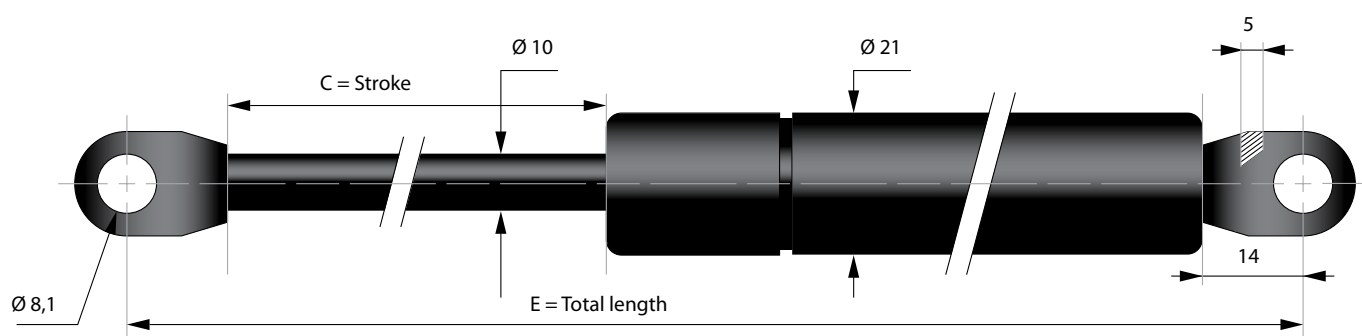

### INSTRUCTIONS FOR ORDERING THE CORRECT TYPE OF GAS SPRINGS:

If you need a gas spring with a piston diameter of 10 mm, with a welded eye, stroke of  $C=300$ mm and with a force of  $F1=800$ N – the spring will have the following order number ST300 800 D10.

C - stroke (mm)	E - length (mm)	F1 - force (N)	Reference
100	285	100 - 1150	ST 100+F1+D10
150	385	100 - 1150	ST 150+F1+D10
200	485	100 - 1150	ST 200+F1+D10
250	585	100 - 1050	ST 250+F1+D10
300	685	100 - 1050	ST 300+F1+D10
330	740	100 - 1050	ST 330+F1+D10
350	785	100 - 1000	ST 350+F1+D10
400	885	100 - 900	ST 400+F1+D10

# COMPRESSION GAS SPRINGS

ENDED WITH M6 THREAD



# COMPRESSION GAS SPRINGS

## WITH PISTON DIAMETER OF 6 mm

Compression gas springs are a multipurpose product of a simple cylindrical shape with different mounting variants producing an extending power under pressurized nitrogen. The compression of the piston rod into the cylinder compresses nitrogen, resulting in the formation of force, which extends the piston from the cylinder. The amount of force depends on the cross section of the piston rod, the cylinder volume and the amount of nitrogen therein.

Gas springs are ended with M6 thread, for which there is a wide range of end fittings. End fittings for this type of spring can be found in many materials specified on pages 13, 14 and 15. The piston rod is made of C35 steel, which is treated by nitriding (QPQ). The cylinder body is made of ST34 2-BK steel and painted with black epoxy paint.

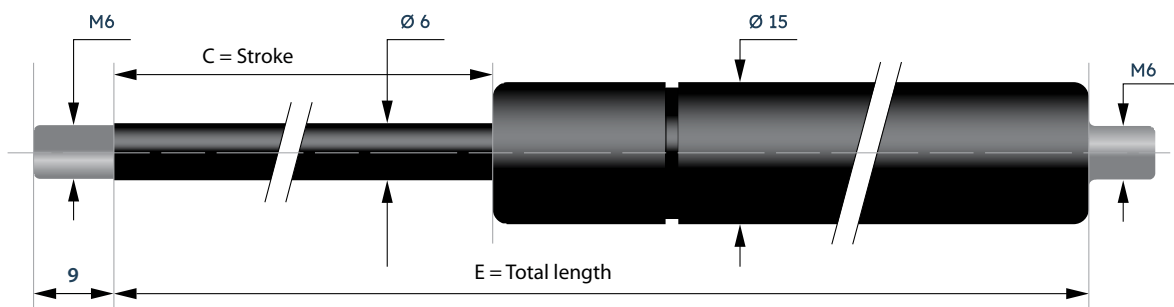

### INSTRUCTIONS FOR ORDERING THE CORRECT TYPE OF GAS SPRINGS:

If you need a gas spring with a piston diameter of 6 mm, ended with a M6 thread, stroke of C=100mm and with a force of F1=200N - the spring will have the following order number ST100 200 V D6.

C - stroke (mm)	E - length (mm)	F1 - force (N)	Reference
20	80	30 - 250	ST 020+F1 V+D6
40	115	30 - 400	ST 040+F1 V+D6
60	155	30 - 400	ST 060+F1 V+D6
80	195	30 - 400	ST 080+F1 V+D6
100	225	30 - 400	ST 100+F1+D6E225
100	235	30 - 400	ST 100+F1 V+D6
120	275	30 - 400	ST 120+F1 V+D6
150	335	30 - 400	ST 150+F1 V+D6

### FUNCTION DIAGRAM OF COMPRESSION GAS SPRING

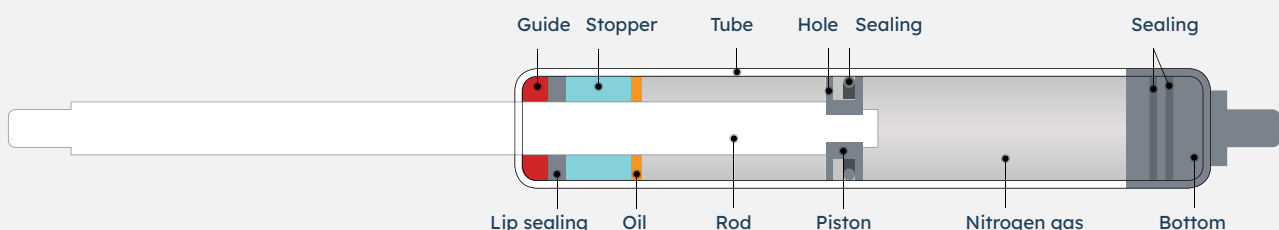

# COMPRESSION GAS SPRINGS

## WITH PISTON DIAMETER OF 8 mm

Compression gas springs are a multipurpose product of a simple cylindrical shape with different mounting variants producing an extending power under pressurized nitrogen. The compression of the piston rod into the cylinder compresses nitrogen, resulting in the formation of force, which extends the piston from the cylinder. The amount of force depends on the cross section of the piston rod, the cylinder volume and the amount of nitrogen therein.

Gas springs are ended with M6 thread which is available with wide range of end fittings. The piston rod is made of C35 steel, which is treated by nitriding (QPQ). The cylinder body is made of ST34 2-BK steel and painted with black epoxy paint.

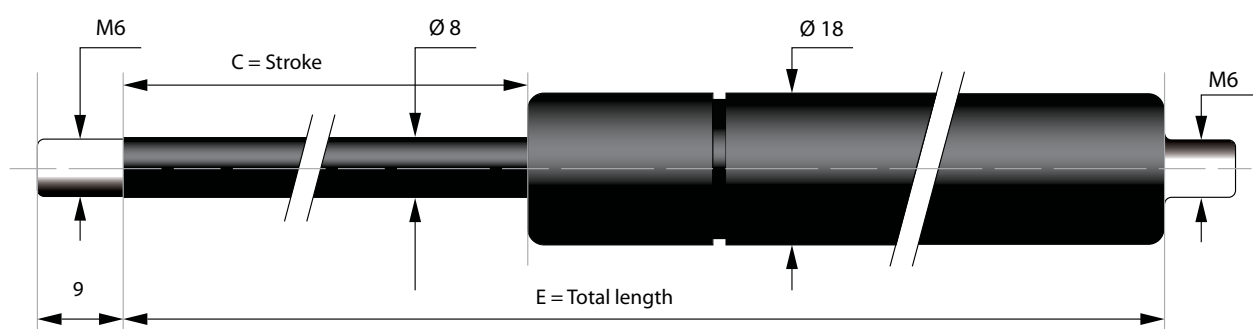

### INSTRUCTIONS FOR ORDERING THE CORRECT TYPE OF GAS SPRINGS:

If you need a gas spring with a piston diameter of 8 mm, finished with a M6 thread, stroke of C=100mm and with a force of F1=500N - the spring will have the following order number ST100 500 V D8.

C - stroke (mm)	E - length (mm)	F1 - force (N)	Reference
40	125	50 - 750	ST 040+F1 V+D8
60	165	50 - 750	ST 060+F1 V+D8
70	183	50 - 750	ST 070+F1 V+D8
80	205	50 - 750	ST 080+F1 V+D8
89	268	50 - 750	ST 089+F1 V+D8
90	225	50 - 750	ST 090+F1 V+D8
100	245	50 - 750	ST 100+F1 V+D8
120	285	50 - 750	ST 120+F1 V+D8
140	325	50 - 750	ST 140+F1 V+D8
150	345	50 - 750	ST 150+F1 V+D8
160	365	50 - 750	ST 160+F1 V+D8
180	405	50 - 700	ST 180+F1 V+D8
200	445	50 - 700	ST 200+F1 V+D8
220	485	50 - 700	ST 220+F1 V+D8
250	545	50 - 700	ST 250+F1 V+D8
250	600	50 - 700	ST 250+F1 V+D8E600
300	645	50 - 500	ST 300+F1 V+D8

# END FITTINGS FOR GAS SPRINGS

## ENDED WITH M6

USED FOR GAS SPRINGS WITH PISTON DIAMETER OF 6 MM AND 8 MM

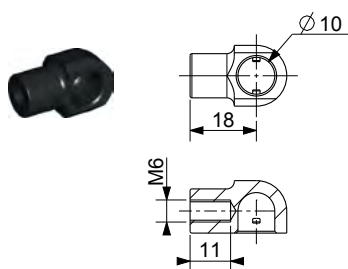

**REF 72421**  
plastic

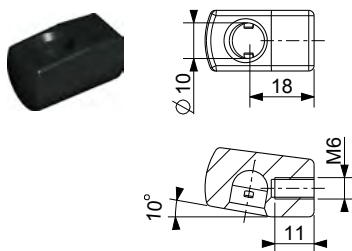

**REF ST 07 2421-110**  
plastic

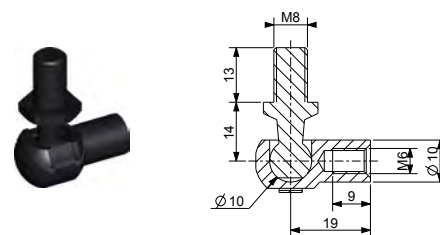

**REF 72421AC-10E**  
metal

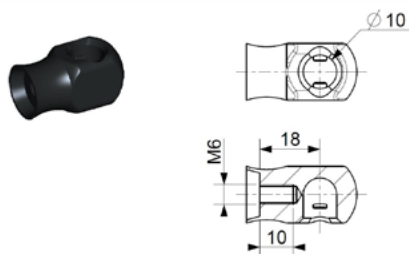

**REF 72421AT**  
plastic

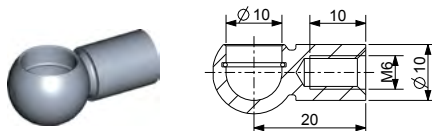

**REF 92221**  
metal

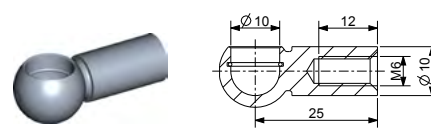

**REF 92220**  
metal

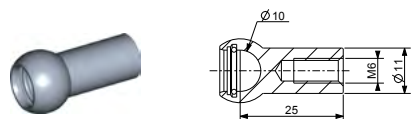

**REF 92220A**  
metal

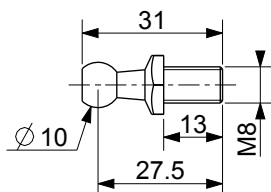

**REF 92990**  
metal

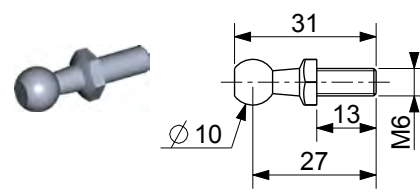

**REF 92989**  
metal

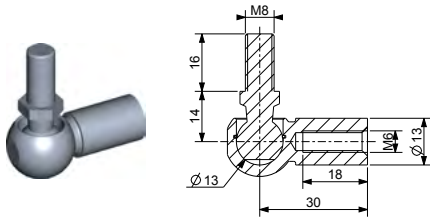

**REF 92220-13 E**  
metal

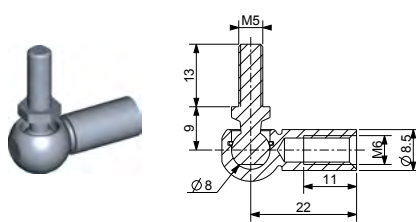

**REF 92220-6-5**  
metal

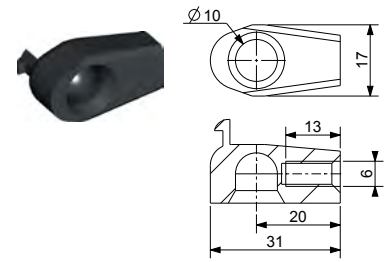

**REF 92722**  
plastic

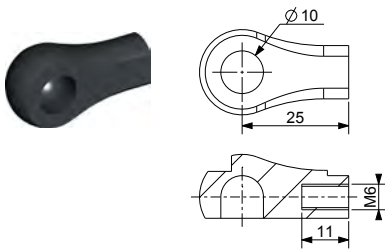

**REF 92720**  
plastic

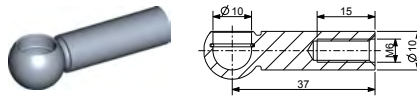

**REF 92220-37**  
metal

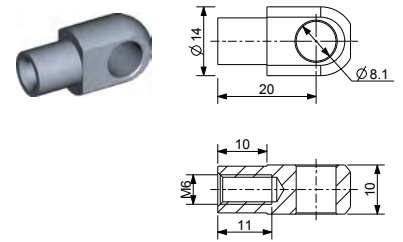

**REF HG CHM6**  
metal

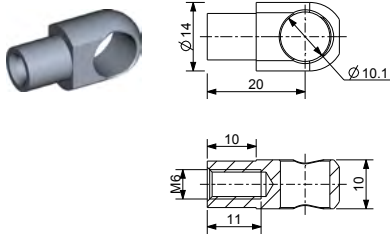

**REF HG CHM6-10**  
metal

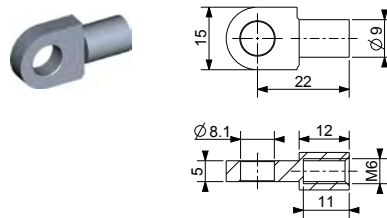

**REF ST 1304**  
metal

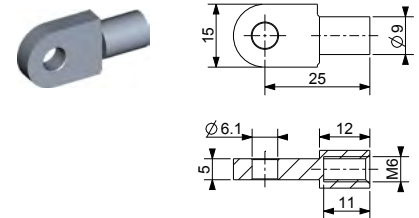

**REF ST 1305**  
metal

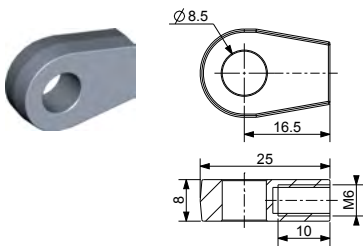

**REF 92259**  
zinc alloy

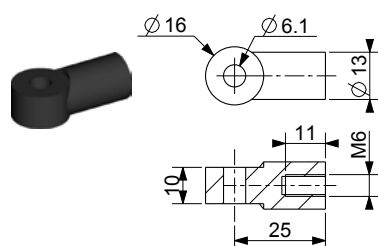

**REF 92528**  
plastic

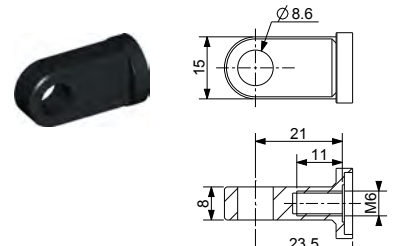

**REF 92521**  
plastic



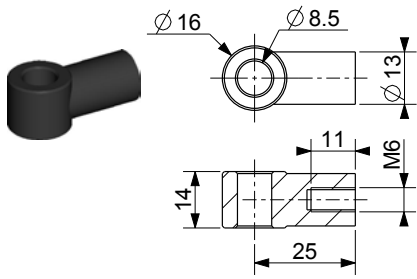

**REF 92522**  
plastic

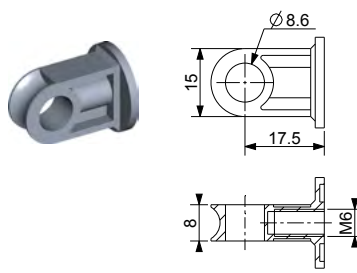

**REF 92263**  
aluminum

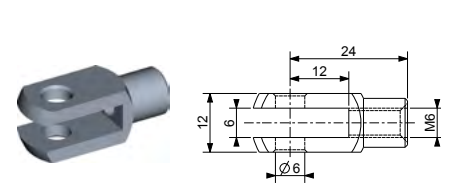

**REF ST F6**  
metal

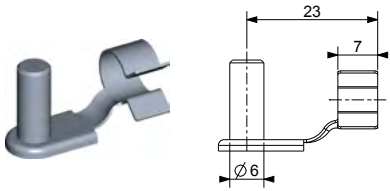

**REF ST ES 6**  
metal

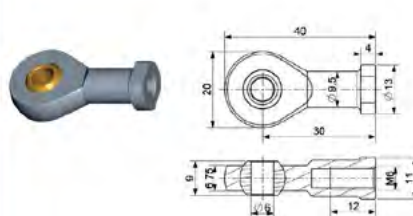

**REF ST G16**  
metal



# COMPRESSION GAS SPRINGS

ENDED WITH M8 THREAD



# COMPRESSION GAS SPRINGS

## WITH PISTON DIAMETER OF 10 mm

Compression gas springs are a multipurpose product of a simple cylindrical shape with different mounting variants producing an extending power under pressurized nitrogen. The compression of the piston rod into the cylinder compresses nitrogen, resulting in the formation of force, which extends the piston from the cylinder. The amount of force depends on the cross section of the piston rod, the cylinder volume and the amount of nitrogen therein.

Gas springs are ended with M8 thread, for which there is a wide range of end fittings. The piston rod is made of C35 steel, which is treated by nitriding (QPQ). The cylinder body is made of ST34 2-BK steel and painted with black epoxy paint.

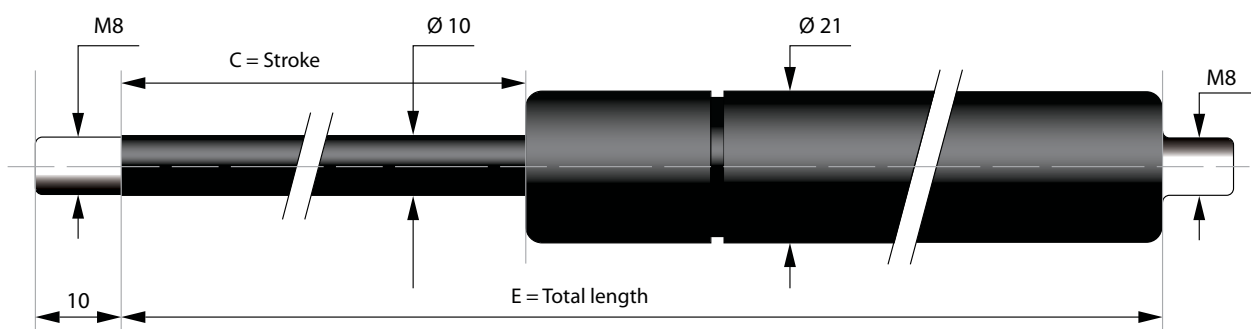

### INSTRUCTIONS FOR ORDERING THE CORRECT TYPE OF GAS SPRINGS:

If you need a gas spring with a piston diameter of 10 mm, ended with a M8 thread, stroke of C=300mm and with a force of F1=800N - the spring will have the following order number ST300 800 V D10.

C - stroke (mm)	E - length (mm)	F1 - force (N)	Reference
60	180	100 - 1150	ST 060+F1 V+D10
100	255	100 - 1150	ST 100+F1 V+D10
115	275	100 - 1150	ST115+F1 V+D10
150	355	100 - 1150	ST 150+F1 V+D10
150	405	250 - 1150	ST 150+F1 V+D10E405
200	455	100 - 1150	ST 200+F1 V+D10
250	555	100 - 1050	ST 250+F1 V+D10
250	610	100 - 1050	ST 250+F1 V+D10E610
300	655	100 - 1050	ST 300+F1 V+D10
300	711	100 - 1050	ST 300+F1 V+D10E711
350	735	100 - 1000	ST 350+F1 V+D10E735
350	755	100 - 1000	ST 350+F1 V+D10
400	855	100 - 900	ST 400+F1 V+D10
440	960	100 - 900	ST 440+F1 V+D10E960
500	1055	100 - 700	ST 500+F1 V+D10
550*	1155	100 - 700	ST 550+F1 V+D10VA
600*	1255	100 - 700	ST 600+F1 V+D10VA
650*	1355	100 - 700	ST 650+F1 V+D10VA
700*	1455	100 - 700	ST 700+F1 V+D10VA

\*delivery date on request

# COMPRESSION GAS SPRINGS

## WITH PISTON DIAMETER OF 14 mm

Compression gas springs are a multipurpose product of a simple cylindrical shape with different mounting variants producing an extending power under pressurized nitrogen. The compression of the piston rod into the cylinder compresses nitrogen, resulting in the formation of force, which extends the piston from the cylinder. The amount of force depends on the cross section of the piston rod, the cylinder volume and the amount of nitrogen therein.

Gas springs are ended with M8 thread, for which there is a wide range of end fittings. The piston rod is made of C35 steel, which is treated by nitriding (QPQ). The cylinder body is made of ST34 2-BK steel and painted with black epoxy paint.

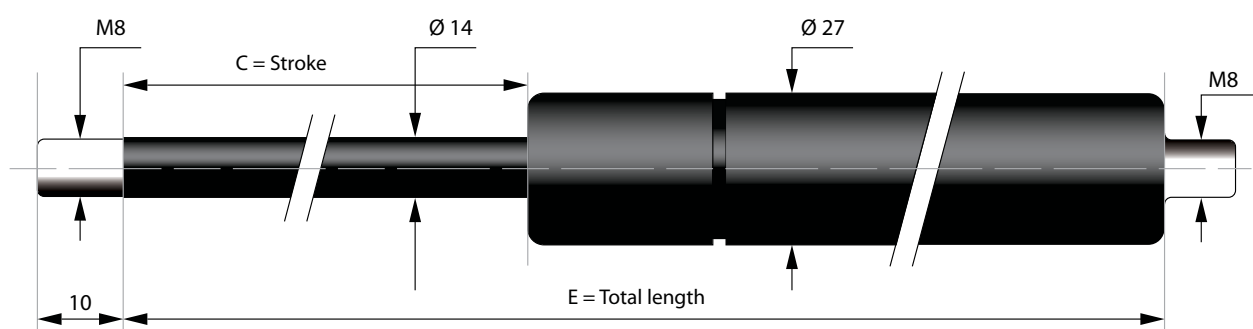

### INSTRUCTIONS FOR ORDERING THE CORRECT TYPE OF GAS SPRINGS:

If you need a gas spring with a piston diameter of 14 mm, ended with a M8 thread, stroke of  $C=250$ mm and with a force of  $F_1=1500$ N – the spring will have the following order number ST250 1500 V D14.

C - stroke (mm)	E - length (mm)	F1 - force (N)	Reference
60	180	100 - 2100	ST 060+F1 V+D14
100	255	100 - 2100	ST 100+F1 V+D14
150	355	200 - 2100	ST 150+F1 V+D14
200	455	300 - 2100	ST 200+F1 V+D14
250	555	300 - 2100	ST 250+F1 V+D14
300	655	300 - 2100	ST 300+F1 V+D14
350	755	300 - 2100	ST 350+F1 V+D14
400	855	300 - 2100	ST 400+F1 V+D14
450	955	300 - 2100	ST 450+F1 V+D14
500	1055	300 - 2100	ST 500+F1 V+D14
600*	1255	300 - 2100	ST 600+F1 V+D14VA
650*	1355	300 - 2100	ST 650+F1 V+D14VA
700*	1435	300 - 1800	ST 700+F1 V+D14VA
750*	1555	300 - 1800	ST 750+F1 V+D14VA
800*	1655	300 - 1500	ST 800+F1 V+D14VA
900*	1855	300 - 1500	ST 900+F1 V+D14VA

\*Ended with M10 threads. Delivery date will be specified upon request.

# END FITTINGS FOR GAS SPRINGS

## ENDED WITH M8

USED FOR GAS SPRINGS WITH PISTON DIAMETER OF 10 MM AND 14 MM

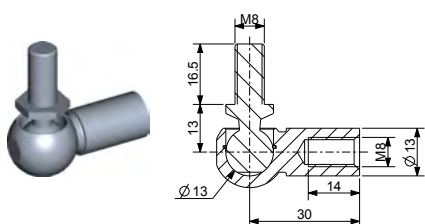

REF 92262  
metal

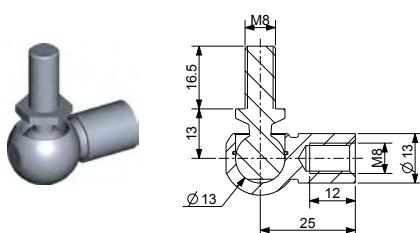

REF 92265  
metal

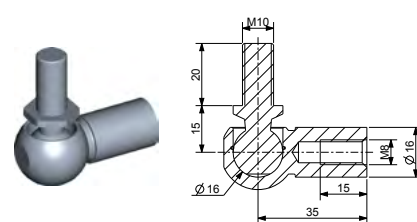

REF 92262-10-8  
metal

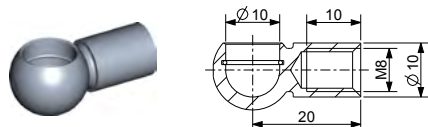

REF 92215  
metal

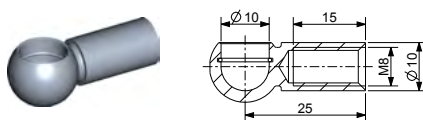

REF 92214  
metal

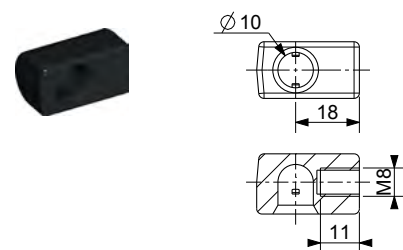

REF 72421-8  
plastic

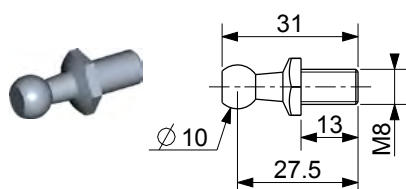

REF 92990  
metal

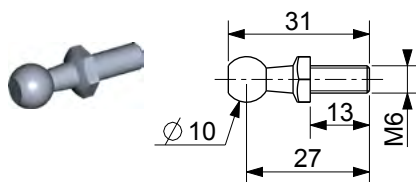

REF 92989  
metal

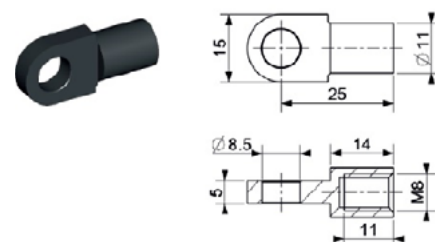

REF HG 92216  
metal

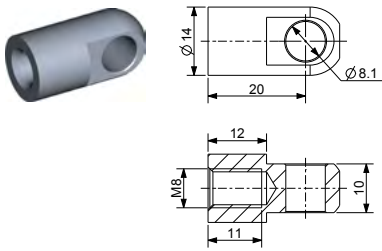

**REF HG CH**  
metal

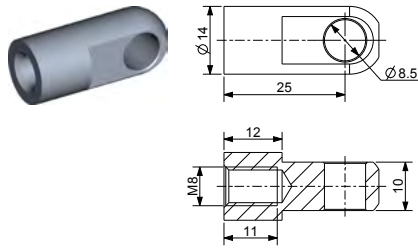

**REF 92264 AC**  
metal

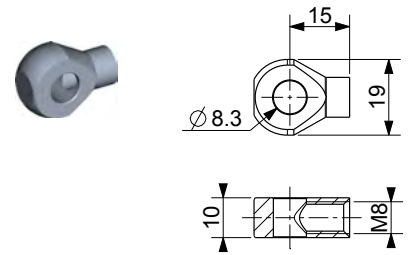

**REF ST M2**  
metal

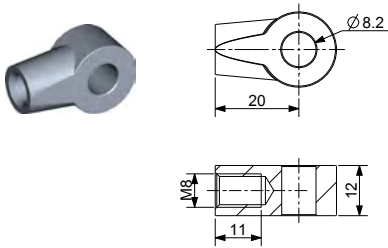

**REF 92261**  
zinc alloy

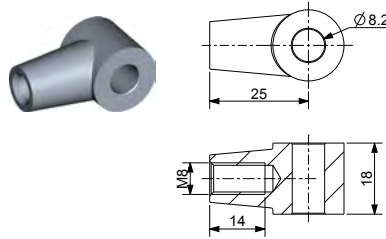

**REF 92260**  
zinc alloy

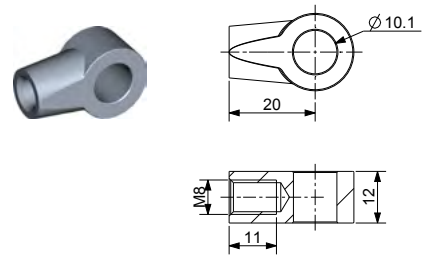

**REF 92267**  
zinc alloy

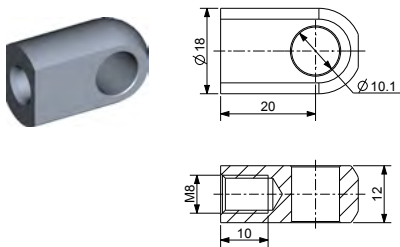

**REF 92267 AC**  
metal

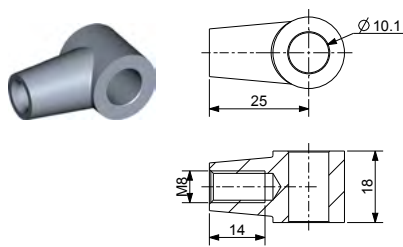

**REF 92266**  
zinc alloy

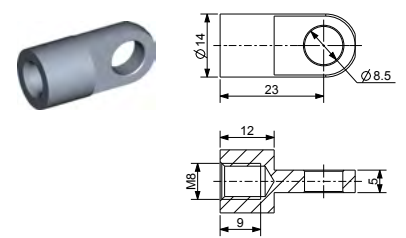

**REF HG 201**  
metal

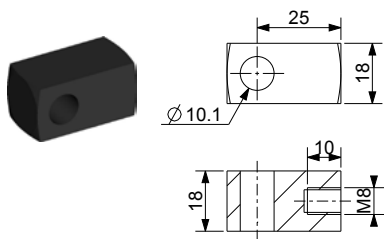

**REF ST 092266N**  
metal

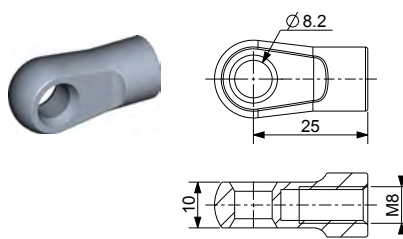

**REF 92264**  
zinc alloy

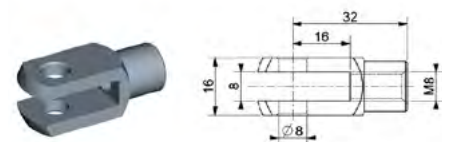

**REF ST F8**  
metal



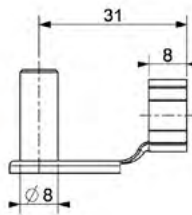

**REF ST ES8**  
zinc alloy

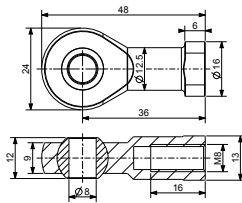

**REF ST G18**  
metal

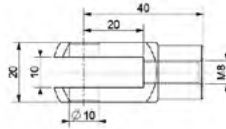

**REF ST F10-8**  
metal

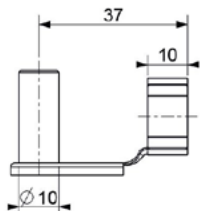
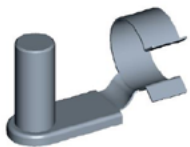

**REF ST ES10**  
zinc alloy



# COMPRESSION GAS SPRINGS

ENDED WITH M10 THREAD



# COMPRESSION GAS SPRINGS

## WITH PISTON DIAMETER OF 14 mm

ENDED WITH M10 THREAD

Compression gas springs are a multipurpose product of a simple cylindrical shape with different mounting variants producing an extending power under pressurized nitrogen. The compression of the piston rod into the cylinder compresses nitrogen, resulting in the formation of force, which extends the piston from the cylinder. The amount of force depends on the cross section of the piston rod, the cylinder volume and the amount of nitrogen therein.

Gas springs are ended with M10 thread, for which there is a wide range of end fittings. The piston rod is made of C35 steel, which is treated by nitriding (QPQ). The cylinder body is made of ST34 2-BK steel and painted with black epoxy paint.

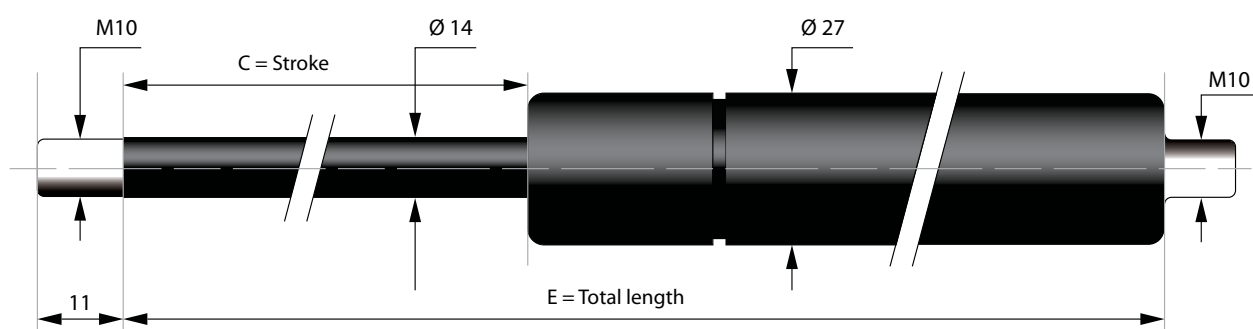

### INSTRUCTIONS FOR ORDERING THE CORRECT TYPE OF GAS SPRINGS:

If you need a gas spring with a piston diameter of 14 mm, ended with a M10 thread, stroke of  $C=400$ mm and with a force of  $F1=1500$ N – the spring will have the following order number ST400 1500 V D14 M10.

C - stroke (mm)	E - length (mm)	F1 - force (N)	Reference
150	368	200 - 2400	ST 150 + F1 V + D14 E368 M10
200	455	200 - 2400	ST 200 + F1 V + D14 M10
250	555	200 - 2400	ST 250 + F1 V + D14 M10
300	655	300 - 2400	ST 300 + F1 V + D14 M10
350	755	300 - 2400	ST 350 + F1 V + D14 M10
400	855	300 - 2400	ST 400 + F1 V + D14 M10
450	955	300 - 2400	ST 450 + F1 V + D14 M10
500	1055	300 - 2100	ST 500 + F1 V + D14 M10
600	1255	300 - 2100	ST 600 + F1 V + D14 VA
650	1355	300 - 2100	ST 650 + F1 V + D14 VA
700	1455	300 - 1800	ST 700 + F1 V + D14 VA
750	1555	300 - 1800	ST 750 + F1 V + D14 VA
800	1655	300 - 1500	ST 800 + F1 V + D14 VA
900	1855	300 - 1500	ST 900 + F1 V + D14 VA







# COMPRESSION GAS SPRINGS

ENDED WITH M14 THREAD





# COMPRESSION GAS SPRINGS

## WITH PISTON DIAMETER OF 20 mm

Compression gas springs are a multipurpose product of a simple cylindrical shape with different mounting variants producing an extending power under pressurized nitrogen. The compression of the piston rod into the cylinder compresses nitrogen, resulting in the formation of force, which extends the piston from the cylinder. The amount of force depends on the cross section of the piston rod, the cylinder volume and the amount of nitrogen therein.

Gas springs are ended with M14x1.5 thread, for which there is a wide range of end fittings. The piston rod is made of C35 steel, which is treated by nitriding (QPQ). The cylinder body is made of ST34 2-BK steel and painted with black epoxy paint.

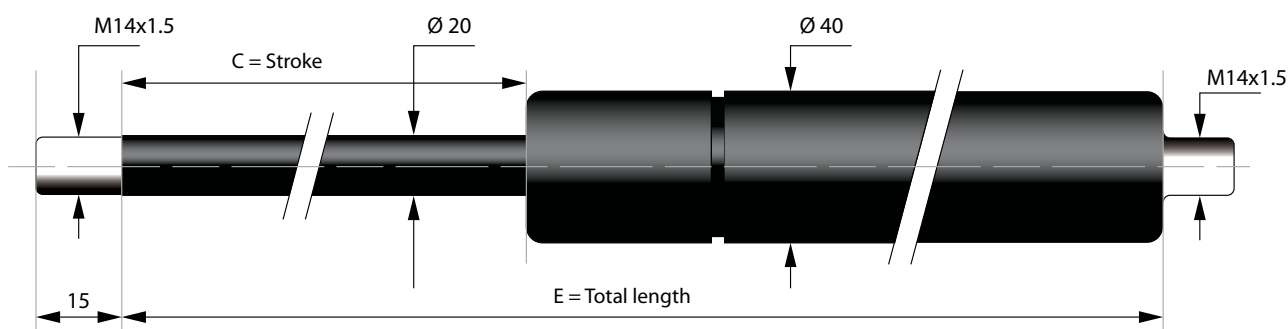

### INSTRUCTIONS FOR ORDERING THE CORRECT TYPE OF GAS SPRINGS:

If you need a gas spring with a piston diameter of 20 mm, ended with a M14 thread, stroke of C=250mm and with a force of F1=3500N – the spring will have the following order number ST250 3500 V D20.

C - stroke (mm)	E - length (mm)	F1 - force (N)	Reference
100	316	300 - 5200	ST 100 + F1 V + D20
150	416	300 - 5200	ST 150 + F1 V + D20
200	516	300 - 5200	ST 200 + F1 V + D20
250	616	300 - 5200	ST 250 + F1 V + D20
300	716	300 - 5200	ST 300 + F1 V + D20
350	816	300 - 5200	ST 350 + F1 V + D20
400	916	300 - 5200	ST 400 + F1 V + D20
500	1116	300 - 5200	ST 500 + F1 V + D20
600	1316	300 - 5000	ST 600 + F1 V + D20
700	1516	300 - 4000	ST 700 + F1 V + D20
800	1716	300 - 4000	ST 800 + F1 V + D20

# END FITTINGS FOR GAS SPRINGS

## ENDED WITH M14

USED FOR GAS SPRINGS WITH PISTON DIAMETER OF 20 MM

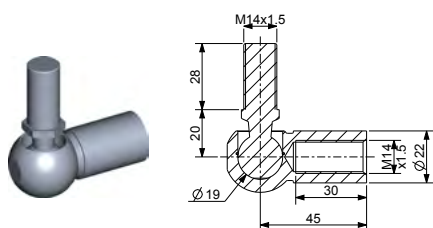

**REF ST 092262-14**  
metal

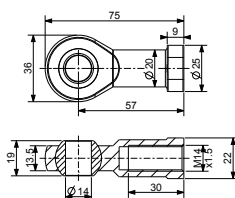

**REF ST Gi14**  
metal

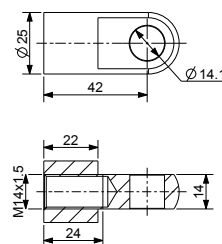

**REF HG CH14**  
metal

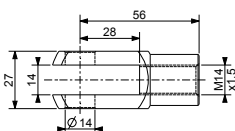

**REF ST F14**  
metal

# BRACKETS FOR MOUNTING GAS SPRINGS

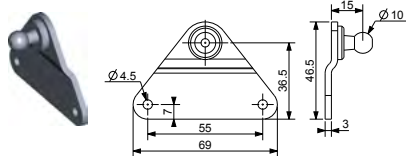

**REF ST 92298**  
metal

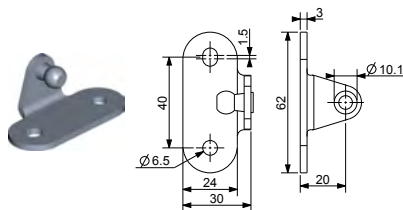

**REF ST 92992**  
metal

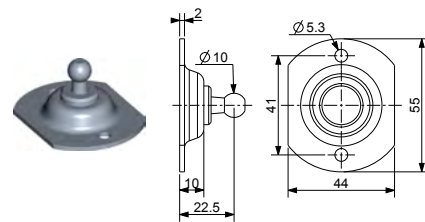

**REF HG 92293**  
metal

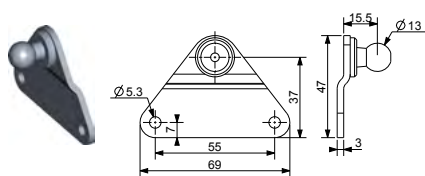

**REF HG BA 01 K13**  
stahl

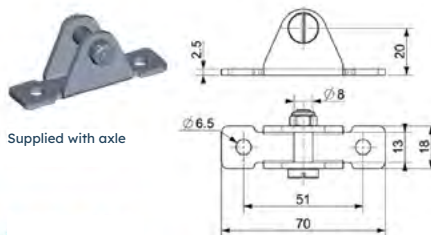

**REF HG 100/2**  
metal

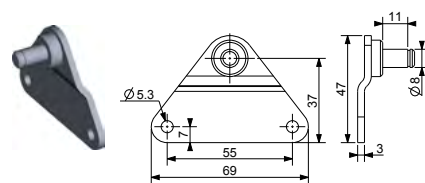

**REF HG 101**  
metal

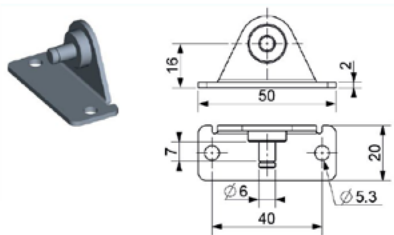

**REF HG BA30Z06**  
metal

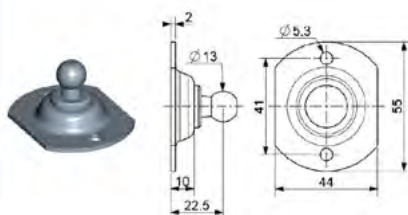

**REF HG92293-13**  
metal

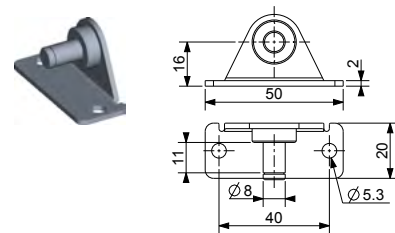

**REF HG BA30Z08**  
metal

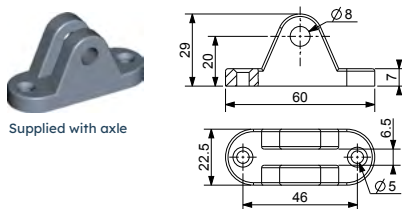

**REF STP100 Ø6 / REF STP100D8 Ø8**  
aluminium

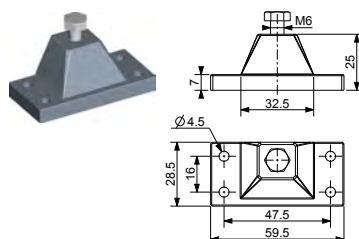

**REF ST P101**  
aluminium

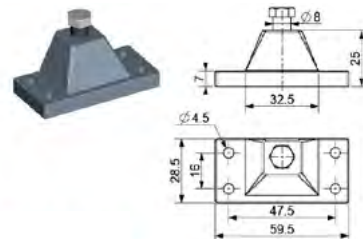

**REF ST P101D8**  
aluminium

# TRACTION GAS SPRINGS

ENDED WITH M8



# TRACTION GAS SPRINGS

The traction gas springs have a special design, which causes the piston rod to be retracted in the spring body, which is also the default position of the piston rod in this type of spring. To pull the piston rod out of the spring body it is necessary to apply a force corresponding to the value of pressure of the traction gas spring.

This type of spring is used to open or close hatches of different types, for lifting loads, in particular where it is not possible to use a compression gas spring.

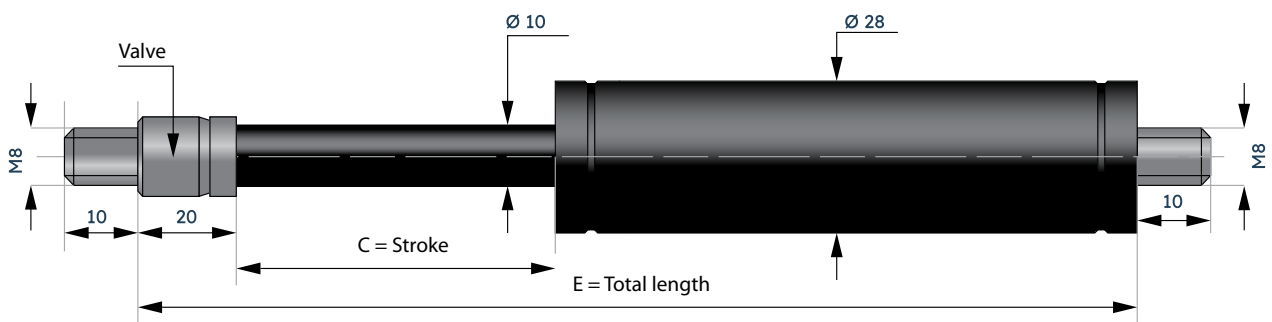

We offer traction gas springs in seven different lengths, pressurized according to customer requirements ranging from 100N - 1200N. The piston rod is made of C35 steel and spring body made of ST34 2-BK steel.

G - stroke (mm)	E - length (mm)	F1 - force (N)	Reference
100	300	100 - 1200	ST T28 100 + F1 V
150	400	100 - 1200	ST T28 150 + F1 V
200	500	100 - 1200	ST T28 200 + F1 V
250	600	100 - 1200	ST T28 250 + F1 V
300	700	100 - 1200	ST T28 300 + F1 V
350	800	100 - 1200	ST T28 350 + F1 V
400	900	100 - 1200	ST T28 400 + F1 V

## FUNCTION DIAGRAM OF TRACTION GAS SPRING

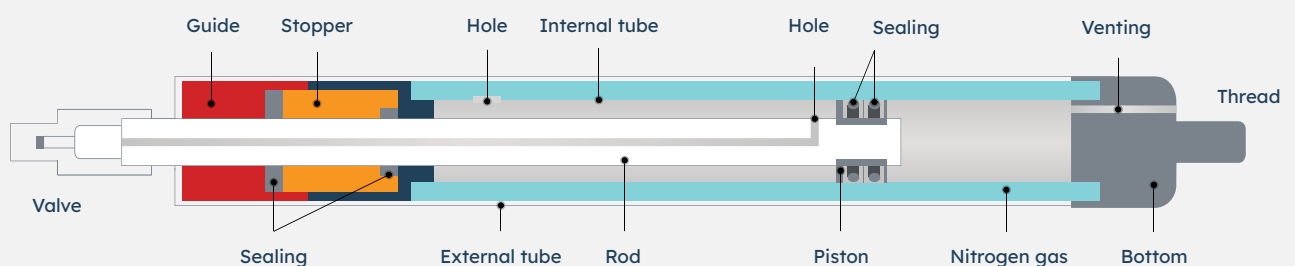

# STAINLESS STEEL GAS SPRINGS

ENDED WITH M8 THREAD





# STAINLESS STEEL GAS SPRINGS

## WITH PISTON DIAMETER OF 8 mm

Compression gas springs are a multipurpose product of a simple cylindrical shape with different mounting variants producing an extending power under pressurized nitrogen. The compression of the piston rod into the cylinder compresses nitrogen, resulting in the formation of force, which extends the piston from the cylinder.

The amount of force depends on the cross section of the piston rod, the cylinder volume and the amount of nitrogen therein. Compression gas springs of stainless steel-types are used in aggressive or otherwise specific environments. The piston rod is made of AISI 316L stainless steel. The spring body is made of AISI 316 stainless steel.

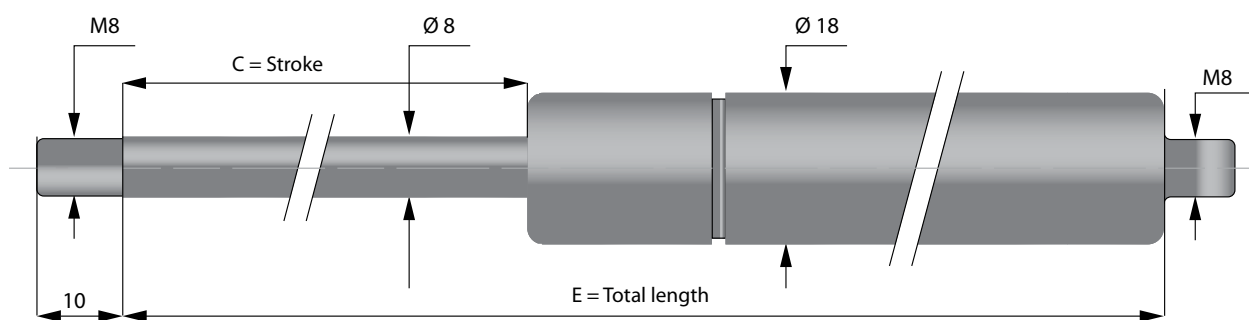

### INSTRUCTIONS FOR ORDERING THE CORRECT TYPE OF GAS SPRINGS:

If you need a gas spring with a piston diameter of 8 mm, ended with a M8 thread, stroke of C=250mm and with a force of F1=500N - the spring will have the following order number ST250 500 V D8iN.

C - stroke (mm)	E - length (mm)	F1 - force (N)	Reference
60	165	50 - 650	ST 060 + F1 V + D8iN
80	205	50 - 650	ST 080 + F1 V + D8iN
100	245	50 - 650	ST 100 + F1 V + D8iN
120	285	50 - 650	ST 120 + F1 V + D8iN
140	325	50 - 650	ST 140 + F1 V + D8iN
160	365	50 - 650	ST 160 + F1 V + D8iN
180	405	50 - 650	ST 180 + F1 V + D8iN
200	445	50 - 650	ST 200 + F1 V + D8iN
250	545	50 - 650	ST 250 + F1 V + D8iN

# STAINLESS STEEL GAS SPRING

## WITH PISTON DIAMETER OF 10 mm

Compression gas springs are a multipurpose product of a simple cylindrical shape with different mounting variants producing an extending power under pressurized nitrogen. The compression of the piston rod into the cylinder compresses nitrogen, resulting in the formation of force, which extends the piston from the cylinder.

The amount of force depends on the cross section of the piston rod, the cylinder volume and the amount of nitrogen therein. Compression gas springs of stainless steel-types are used in aggressive or otherwise specific environments. The piston rod is made of AISI 316L stainless steel. The spring body is made of AISI 316 stainless steel.

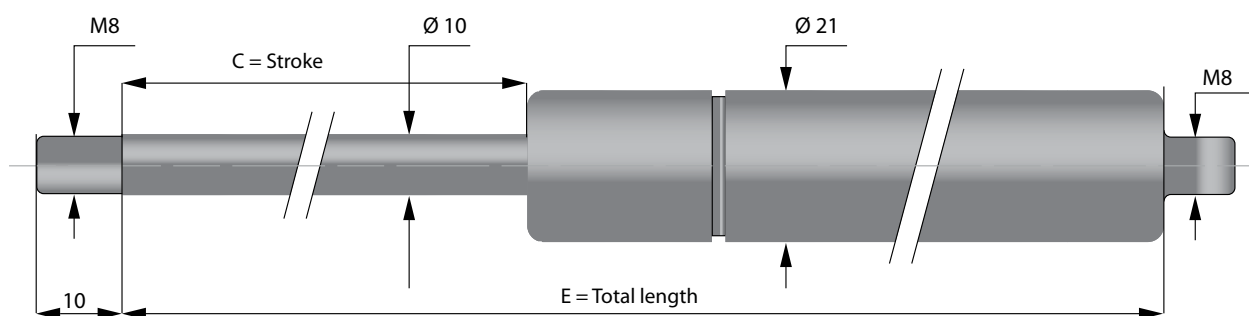

### INSTRUCTIONS FOR ORDERING THE CORRECT TYPE OF GAS SPRINGS:

If you need a gas spring with a piston diameter of 10 mm, ended with a M8 thread, stroke of C=300mm and with a force of F1=800N – the spring will have the following order number ST300 800 V D10iN.

C - stroke (mm)	E - length (mm)	F1 - force (N)	Reference
100	255	100 - 1000	ST 100 + F1 V + D10iN
150	355	100 - 1000	ST 150 + F1 V + D10iN
200	455	100 - 1000	ST 200 + F1 V + D10iN
250	555	100 - 1000	ST 250 + F1 V + D10iN
300	655	100 - 1000	ST 300 + F1 V + D10iN
350	755	100 - 900	ST 350 + F1 V + D10iN
400	855	100 - 800	ST 400 + F1 V + D10iN
500	1055	100 - 800	ST 500 + F1 V + D10iN

# STAINLESS STEEL GAS SPRINGS

## WITH PISTON DIAMETER OF 14 mm

Compression gas springs are a multipurpose product of a simple cylindrical shape with different mounting variants producing an extending power under pressurized nitrogen. The compression of the piston rod into the cylinder compresses nitrogen, resulting in the formation of force, which extends the piston from the cylinder.

The amount of force depends on the cross section of the piston rod, the cylinder volume and the amount of nitrogen therein. Compression gas springs of stainless steel-types are used in aggressive or otherwise specific environments. The piston rod is made of AISI 316L stainless steel. The spring body is made of AISI 316 stainless steel.

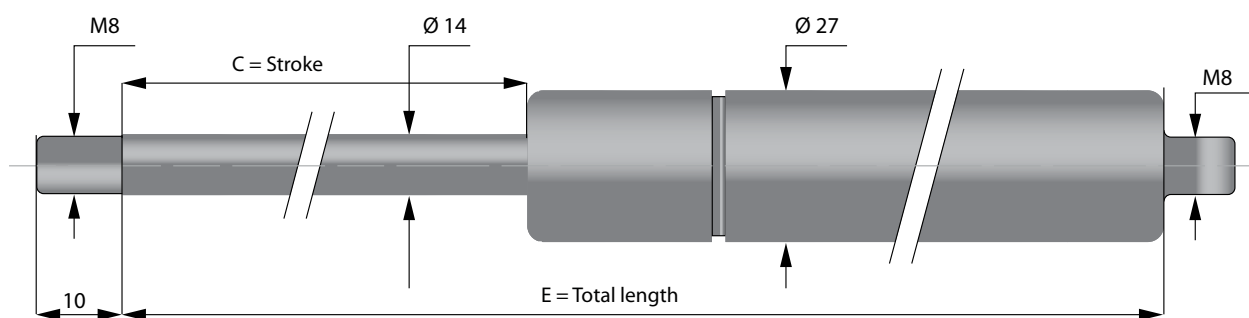

### INSTRUCTIONS FOR ORDERING THE CORRECT TYPE OF GAS SPRINGS:

If you need a gas spring with a piston diameter of 14 mm, ended with a M8 thread, stroke of C=400mm and with a force of F1=1500N - the spring will have the following order number ST400 1500 V D14iN.

C - stroke (mm)	E - length (mm)	F1 - force (N)	Reference
150	355	200 - 2100	ST 150 + F1 V + D14iN
200	455	200 - 2100	ST 200 + F1 V + D14iN
250	555	200 - 2100	ST 250 + F1 V + D14iN
300	655	200 - 2100	ST 300 + F1 V + D14iN
350	755	200 - 2100	ST 350 + F1 V + D14iN
400	855	200 - 2100	ST 400 + F1 V + D14iN
500	1055	200 - 2100	ST 500 + F1 V + D14iN

# END FITTINGS AND BRACKETS

## FOR STAINLESS STEEL GAS SPRINGS

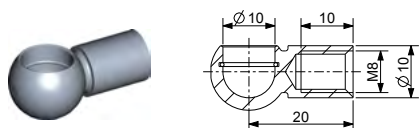

**REF 92215i**  
inox

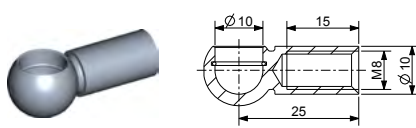

**REF 92214i**  
inox

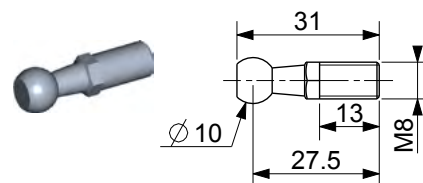

**REF 92990i**  
inox

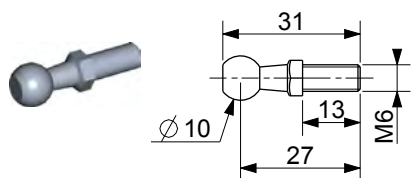

**REF 92989i**  
inox

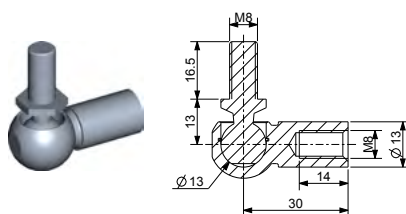

**REF 92262i**  
inox

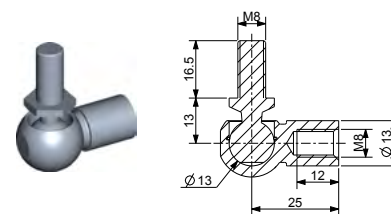

**REF 92265i**  
inox

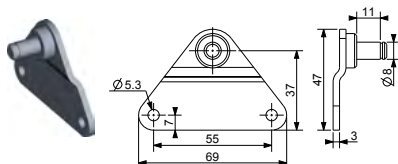

**REF HG 101i**  
inox

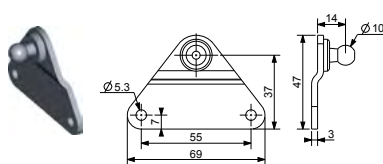

**REF BA01K10i**  
inox

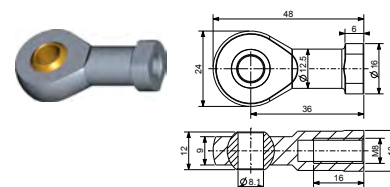

**REF ST Gi8i**  
inox

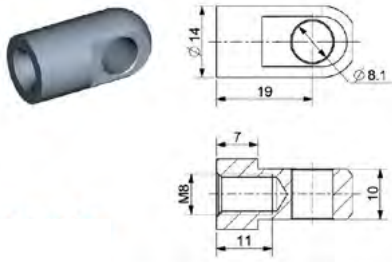

**REF HG CHI**  
inox

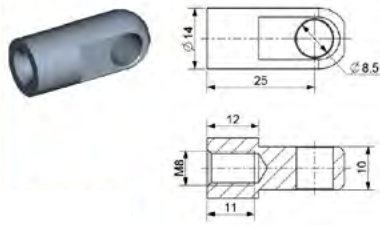

**REF ST 092264i**  
inox

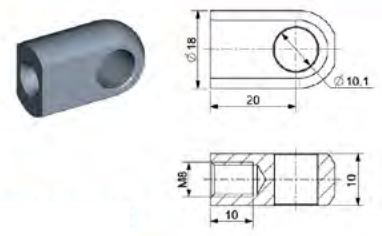

**REF ST 92267i**  
inox

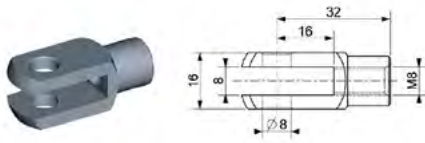

**REF ST F8iN**  
inox

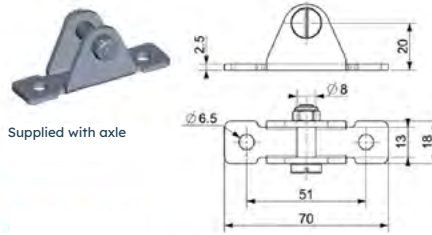

Supplied with axle

**REF HG 100/2i**  
inox



# OTHER ACCESSORIES OF GAS SPRINGS

## PROTECTION TUBE

The protection tube protects the piston rod of the gas spring against mechanical or chemical damage. It is mainly used in polluted environments or in environments where there is an increased risk of mechanical damage.

It is made of ST34 steel, which is painted with epoxy paint. This component can be used only in gas springs ended with a thread.

## WIPER RING

ST RAC wiper ring protects the internal seal of the gas spring against surrounding contaminants that may reduce its life. ST RAC consists of a scraper (aluminium + nitrile NBR 90SH) and a cap made of PVC. This component is not compatible with safety or protective tubes and can be used only with gas spring ended with a thread.

## BLOCKING TUBE

The blocking tube allows the locking of the gas spring in the extreme (open) position. Releasing the lock is attained by the slight lifting of the load. This component is made of STN 34 steel, which is painted in black epoxy paint. Blocking tubes can only be used with a gas spring ended with a thread.



## ACCESSORIES FOR PRESSURE RELEASE

The release tool is used to reduce the pressure of the gas spring. Short strokes of the release tool relieve the internal pressure until the desired gas spring pressure is reached. It can only be used on BM gas springs equipped with a release valve.

Reference	Thread valve
ST OUT6	M6
ST OUT8	M8
ST OUT10	M10
ST OUT14	M14



## LOCKING TUBES CAN BE USED ON STANDARD SPRING ENDED WITH A THREAD.

The blocking tube is used to lock the hatch in the open position. The blocking tube secures one of the two gas springs in the application, thus ensuring the safe locking of the hatch in the open position.

It can be unlocked by gently lifting the hatch and pressing the locking tube at the marked point.

**THE BLOCKING TUBE WILL SHORTEN YOUR STROKE BY 20 MM.**

Blocking tube for standard gas springs	Blocking tube reference
ST 160+F1 V+D8	ST TUB08160
ST 250+F1 V+D8	ST TUB08250
ST 200+F1 V+D10	ST TUB10200
ST 250+F1 V+D10	ST TUB10250
ST 300+F1 V+D10	ST TUB10300
ST 350+F1 V+D10	ST TUB10350
ST 400+F1 V+D10	ST TUB10400
ST 500+F1 V+D10	ST TUB10500
ST 200+F1 V+D14	ST TUB14200
ST 250+F1 V+D14	ST TUB14250
ST 300+F1 V+D14	ST TUB14300
ST 350+F1 V+D14	ST TUB14350
ST 400+F1 V+D14	ST TUB14400
ST 450+F1 V+D14	ST TUB14450
ST 500+F1 V+D14	ST TUB14500

## Contact

+372 600 60 63

info@elsenta.ee

# elsenta

## ELSENTA OÜ

Treiali tee 2 Peetri  
Rae vald, Harjumaa, 75312, Estonia

[www.elsenta.ee](http://www.elsenta.ee)  
[products.elsenta.ee](http://products.elsenta.ee)